



INSTALLATION INSTRUCTIONS FOR PART 99-7320

APPLICATIONS 2006 Hyundai Sonata

99-7320



KIT FEATURES

- DIN head unit provision

KIT COMPONENTS

A) Radio Housing

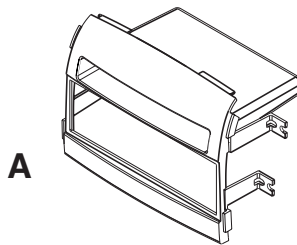

TOOLS REQUIRED:

Phillips Screwdriver | Small Flat Blade Screwdriver

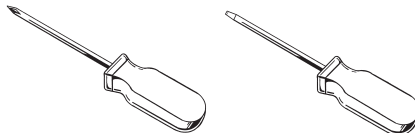

1-800-221-0932



www.metraonline.com

© COPYRIGHT 2004 METRA ELECTRONICS CORPORATION



TABLE OF CONTENTS

***Dash Disassembly** 1*

***Kit Assembly** 2*

***Final Assembly** 3*

2006 HYUNDAI SONATA

- 1 Disconnect the negative battery terminal to prevent an accidental short circuit.
- 2 Open glove box and remove (2) Phillips screws from top edge of glove box opening and bottom edge of wood trim below radio. (Figure A)
- 3 Unclip and remove wood trim from below radio and above glove box. (Figure B)
- 4 Remove (1) Phillips screw per side panel next to radio then unclip and remove panels. (Figure C)
- 5 Remove (6) Phillips screws from radio to extract from sub dash. (Figure D)

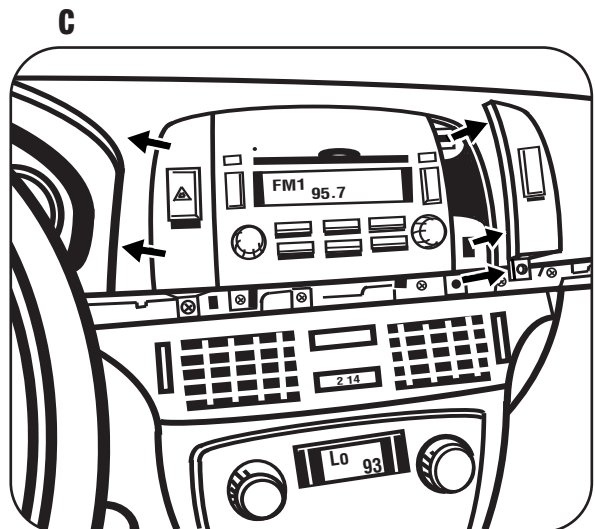
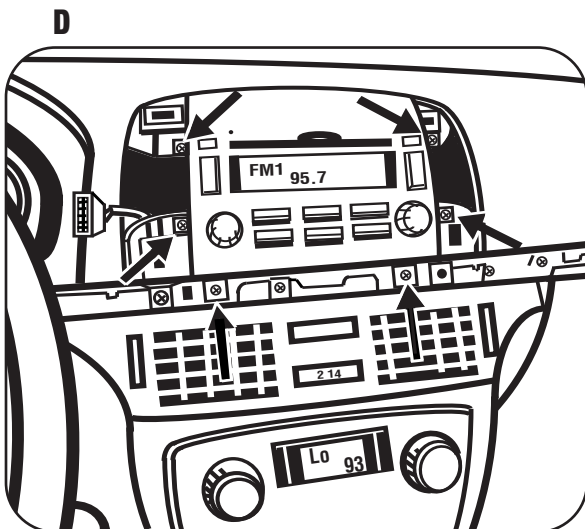
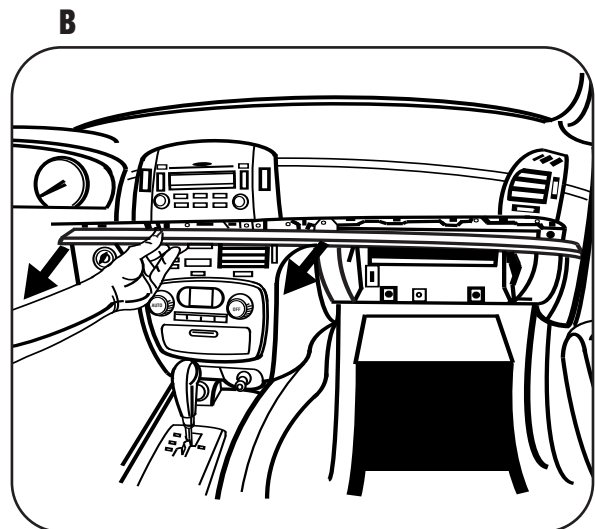
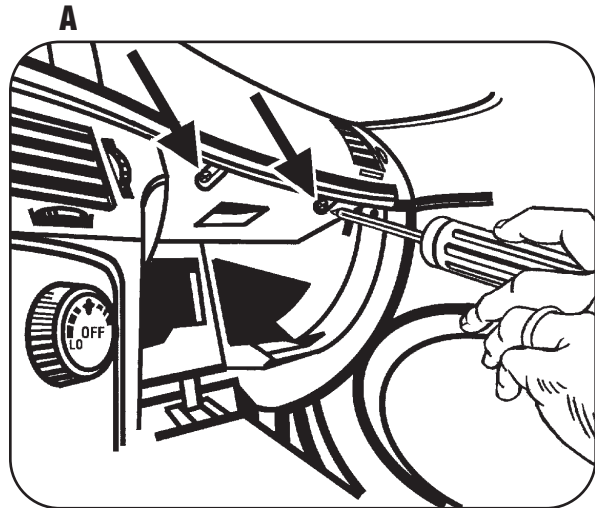

DIN HEAD UNIT PROVISION

- 1** Slide the DIN cage into the Radio Housing and secure by bending the metal locking tabs down. (Figure A)
- 2** Slide the aftermarket head unit into the cage and secure. (Figure B)

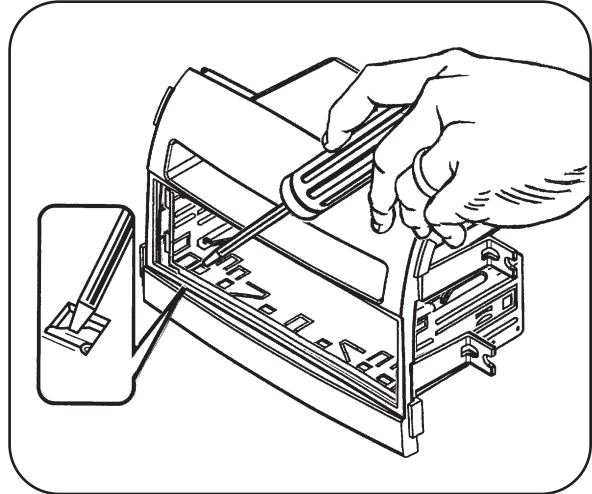
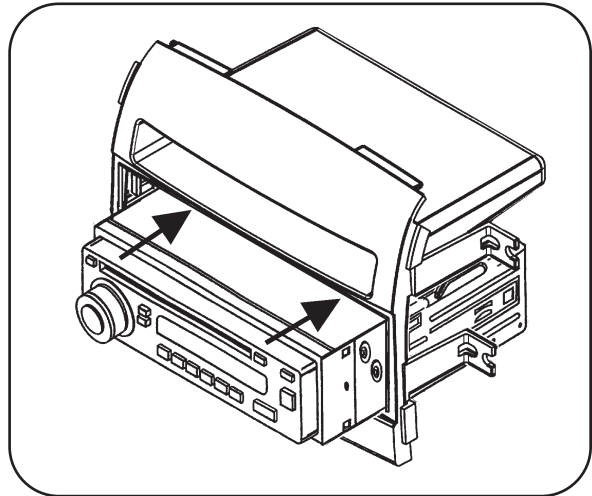
A**B**

FINAL ASSEMBLY

- 1** Locate the factory wiring harness in the dash and make the connection as shown. Metra recommends using the proper mating adapter and making the connections as shown. (Isolate and individually tape off the ends of any unused wires to prevent electrical short circuit.)
- 2** Re-connect the negative battery terminal and test the unit for proper operation.
- 3** Reassemble radio and dash assemblies in reverse order of disassembly.

FINAL WIRING CONNECTIONS

Make wiring connections using the EIA color code chart shown below and the instructions included with the head unit. Metra recommends making connections as shown below; Strip, Splice, Solder, Tape. Isolate and individually tape off ends of any unused wires to prevent electrical short circuit.

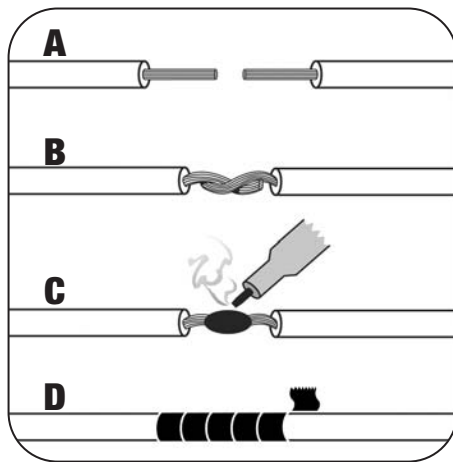

- A) Strip wire ends back 1/2"**
- B) Twist ends together**
- C) Solder**
- D) Tape**

METRA / EIA WIRING CODE

12V Ignition / Acc . . . Red	Right Front (+) Gray
12V Batt / Memory . . Yellow	Right Front (-) Gray / Black
Ground Black*	Left Front (+) White
Power Antenna Blue	Left Front (-) White / Black
Amp Turn-On Blue / White	Right Rear (+) Violet
Amp Ground Black / White	Right Rear (-) Violet / Black
Illumination Orange	Left Rear (+) Green
Dimmer Orange / White	Left Rear (-) Green / Black

***NOTE:** When Black a wire is not present, ground radio to vehicle chassis.
All colors may not be present on all leads due to manufacturer's specifications.

99-7320 INSTRUCTIONS



1-800-221-0932



www.metraonline.com

REV. 09/22/05

© COPYRIGHT 2004 METRA ELECTRONICS CORPORATION

INST99-7320