



INSTALLATION INSTRUCTIONS FOR PART 99-8224

APPLICATIONS

Toyota Matrix 2009

Pontiac Vibe 2009

(Excluding Factory Navigation Models)

99-8224



KIT FEATURES

- DIN Radio Provision With Pocket
- ISO Mount Radio Provision With Pocket

KIT COMPONENTS

- A) Rading Housing
- B) ISO Brackets
- C) Trim Plate

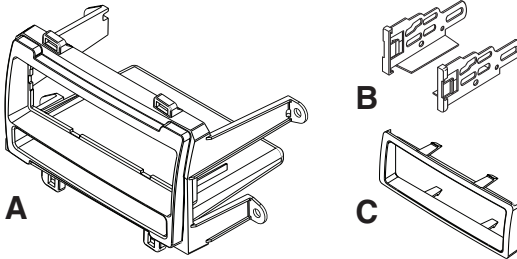

TOOLS REQUIRED:

- Small Flat Blade Screwdriver/ Panel Removal Tool
- Socket Set



 1-800-221-0932



www.metraonline.com

© COPYRIGHT 2008 METRA ELECTRONICS CORPORATION



TABLE OF CONTENTS

Dash Disassembly

- Toyota Matrix/Pontiac Vibe 2009 1

Kit Assembly

- DIN Radio Provision With Pocket 2

- ISO Mount Radio Provision With Pocket 3

Final Assembly 4

***Note:**

Refer also to the instructions included with the aftermarket radio.

Toyota Matrix/Pontiac Vibe 2009

- 1 Disconnect the negative battery terminal to prevent an accidental short circuit.
- 2 Unclip and remove the radio trim panel including the a/c vent. (Figure A)
- 3 Remove (4) 10 MM bolts securing the radio. Unplug and remove the radio. (Figure B)

Continue to kit preparation.

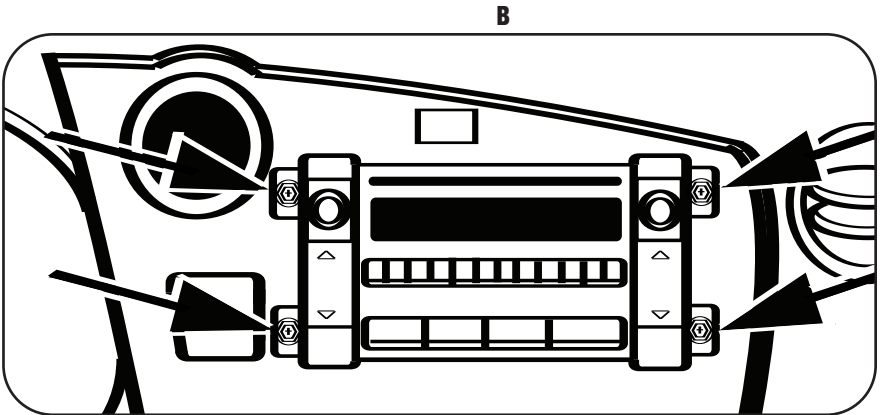
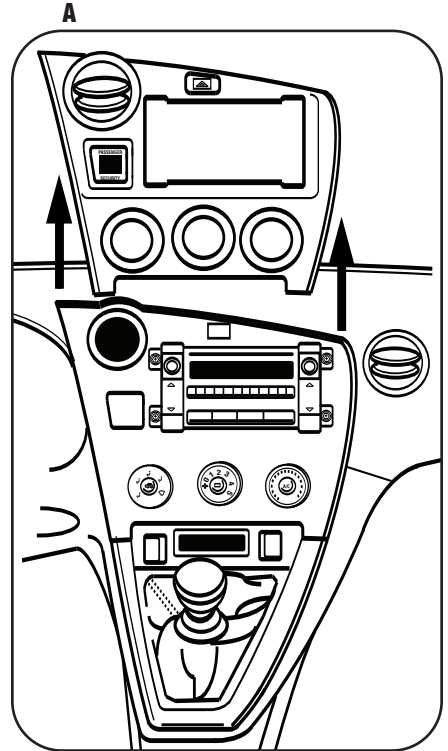

DIN RADIO PROVISION WITH POCKET

**Note: Refer also to the instructions included with the aftermarket radio.*

1 Slide the DIN cage into the Radio Housing and secure by bending the metal locking tabs outward. (Figure A)

2 Slide the aftermarket radio into the cage until it snaps into place. (Figure B)

Continue to final assembly.

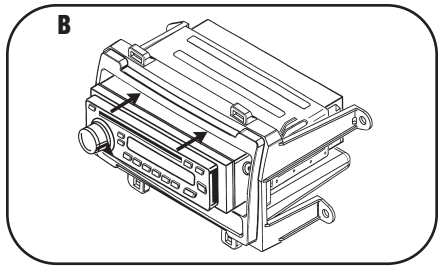
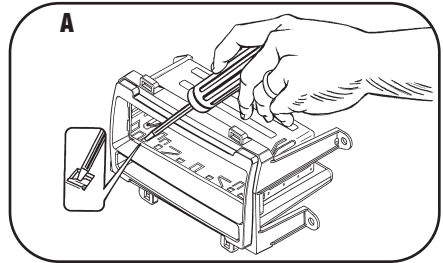

STACKED MOUNT RADIO PROVISION WITH POCKET

**Note: Refer also to the instructions included with the aftermarket radio.*

1 Mount the ISO Brackets to the Radio using the screws supplied with the radio. (Figure A)

2 Slide the Radio into the Radio Housing until the side clips snap into place. (Figure B)

3 Snap the Trim plate into the Radio Housing. (Figure B)

Continue to final assembly.

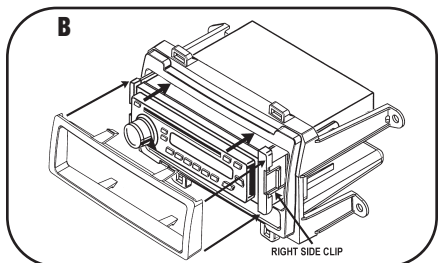
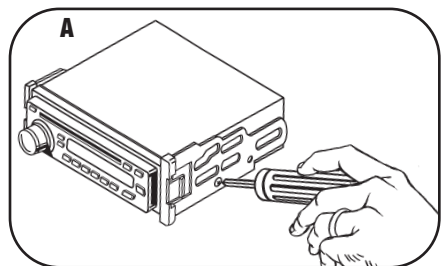

FINAL ASSEMBLY

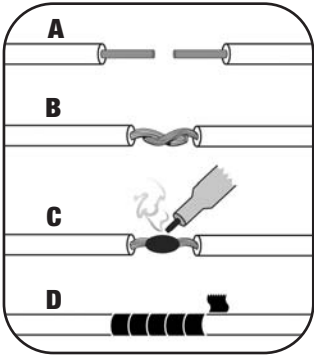

- (A) Strip wire ends back 1/2"**
- B) Twist ends together**
- C) Solder**
- D) Tape**

- 1** Locate the factory wiring harness in the dash. Metra recommends using the proper mating adapter and making connections as shown. (Isolate and individually tape off the ends of any unused wires to prevent electrical short circuit.)
- 2** Re-connect the negative battery terminal and test the unit for proper operation.
- 3** Reassemble radio and dash assemblies in reverse order of disassembly.

FINAL WIRING CONNECTIONS

Make wiring connections using the EIA color code chart shown below and the instructions included with the head unit. Metra recommends making connections as shown below; Strip, Splice, Solder, Tape. Isolate and individually tape off ends of any unused wires to prevent electrical short circuit.

METRA / EIA WIRING CODE

12V Ignition / Acc. Red	Right Front (+) Gray
12V Batt / Memory Yellow	Right Front (-) Gray/ Black
Ground Black*	Left Front (+) White
Power Antenna Blue	Left Front (-) White / Black
Amp Turn-On Blue / White	Right Rear (+) Violet
Amp Ground Black / White	Right Rear (-) Violet / Black
Illumination Orange	Left Rear (+) Green
Dimmer Orange / White	Left Rear (-) Green / Black

***NOTE:** When a Black wire is not present, ground radio to vehicle chassis.
 All colors may not be present on all leads due to manufacturer's specifications.

99-8224 INSTRUCTIONS



1-800-221-0932



www.metraonline.com

REV. 06/27/08 © COPYRIGHT 2008 METRA ELECTRONICS CORPORATION INST99-8224