

6m Vertical Antenna

CP62(2x5/8 wave)

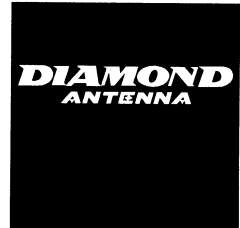

Operation Instructions

To use this antenna properly, read this instruction thoroughly before using it, Keep this manual carefully at hand for later use.

•Description

- ① 1/4 wave ground plane antenna permits longer ground wave propagation range and advantageous for ionospheric reflection DX communication.
- ② Compact, light weighted and very easy to assemble.
- ③ It is completely self-supported and does not need any guy wires.
- ④ It is rigid and rugged enough to withstand the wind pressure over 79MPH.
- ⑤ Mast brackets area adjustable to accept 1 1/5" to 2 1/3" diameter mast.
- ⑥ Feed point section is kept waterproof by covering it with support pipe.

•Parts Description

•Parts Description

Parts #	Description	Qty
M48001	Pipe No. 1 φ10	1
M48002	Pipe No. 2 φ15	1
M48003	Pipe No. 3 φ27	1
M48004	Pipe No. 4 φ30	1
M48005	Phase coil	1
M48006	Hose clamp	1
M48007	Feed point assembly	1
M48008	Radial ring	1
M48009	Radial element	3
M48010	Support pipe	1
M48011	Mast bracket set	2
M48012	V-volt with nut	2
M48013	Radial nut	3
M48014	Tapping screw	6
M48015	Hex head screw M6x8	3
M48016	External tooth washer M4	6
M48017	Spring washer M6	3

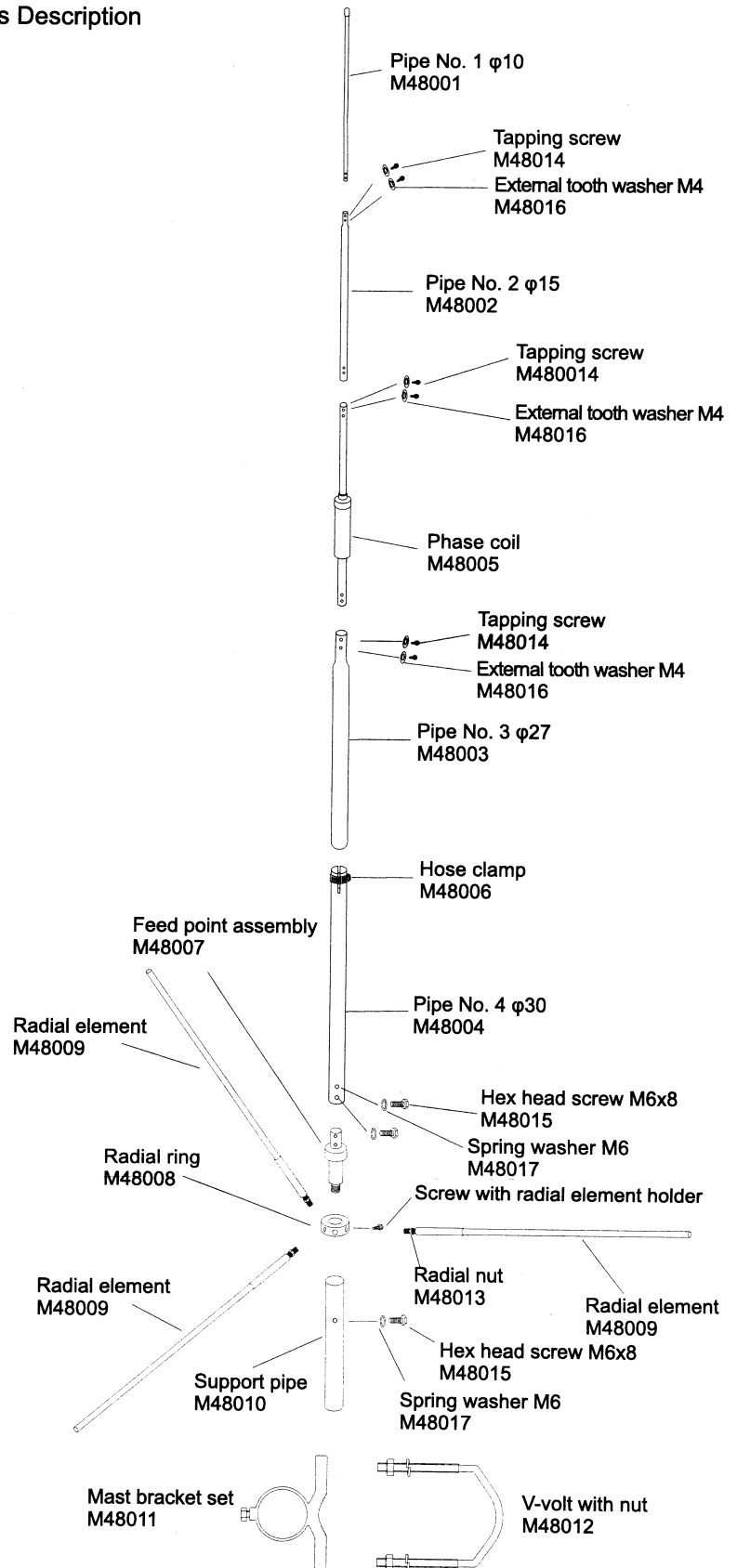

(Fig-1)

-Note-

<<Installing the antenna>>

- ① Don't install on a rainy or windy day since it is dangerous.
- ② Don't attempt to install the antenna only by yourself. Installing the antenna alone on the roof may lead you dangerous accident. Always ask your friends for help installing the antenna.
- ③ Don't drop the antenna, tools and attachment when installing the antenna in the height. Install the antenna before assembling it on the ground.

<<Antenna location>>

- ① If the CP62 is located on the roof of a house or top of a building, look around the roof to see if there are any obstacles such as an electronic wire or TV antenna. The CP62 has to be located as far away as possible from those things to obtain its maximum performance. Installing the antenna too close to the building wall may cause bad effect for electrical characteristics of the antenna.
- ② Don't install the antenna where is easily reachable by people.
- ③ Install the antenna firmly not to fall down due to the strong wind. Even if falling down the antenna, locate the antenna at the safe place where people and building are not inflicted injures.

<<Before transmitting>>

- ① Transmit after confirming if the antenna works normally by an SWR meter. If VSWR is less than 1.5, it is no problem. If VSWR is higher, stop transmitting and check if the parts of the antenna and coaxial cable are connected. If there are tall buildings or obstacles or the distance between the antenna and the ground is short, VSWR may not be lowered.

※Diamond Antenna SWR/POWER meter is an insertion type being connected between a transmitter and an antenna. Transmitting power and SWR can be measured with very simple operations. In addition with those conventional measurement, PEP (peak envelope power) on SSB mode can be measured with a PEP monitor function. With our Diamond's wideband and low insertion loss directional coupler those measurements can be performed with minimum effect in transmission line.

<<During transmitting>>

- ① Touching the antenna during transmission may cause to electrify. Pay attention not to touch

the antenna especially for children if installing on a balcony railing.

<<Rumbling Thunder>>

- ① The thunder seems to rumble in the vicinity, don't touch the antenna and coaxial. When you don't use the radio, take off the cable from the radio.

<<If there is something wrong, stop transmitting immediately.>>

- ① Keeping transmitting with high VSWR may cause the radio to be damaged. Stop transmitting immediately and check the following matters. If it doesn't solve the problem, please ask the dealer or Diamond Antenna Corporation.

[Condition: If the antenna doesn't seem to receive well or propagate well]

Check 1: Is the antenna too close to the building wall? If the obstacles are too close to antenna, VSWR is higher and the radiation pattern is disturbed. Please install the antenna from the building as far away as possible.

Check 2: Did you assemble the antenna correctly? Please read the instruction again and reconfirm the assembly.

Check 3: Is the coaxial cable something wrong? Please check if soldering the connector is okay and the wire breaks by the volt-ohm meter.

•Antenna location

Resonate frequency of HF antenna can change based on location. Antenna should be mounted away from tree, building and other antennas.

- ① If the CP62 is located on the roof of a house or top of a building, look around the roof to see if there are any obstacles such as TV antenna or water reservation tank. The CP62 has to be located as far away as possible from those things to obtain its maximum performance.
- ② If the CP62 is installed on a balcony railing, installing the antenna too close to the building wall may cause bad effect for electrical characteristics of the antenna. Locate at least 2m to 5m (7' to 16') away from the building wall depending on structure of the building.

<<Note>>

In case of using the metallic stay wire, set the wire on the lower mast bracket set and attach the insulators at within 1m from the mast bracket set in order to insulate.

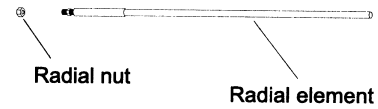

(Fig-2)

•Assembly Instruction

- ① Put radial nut into radial element and fasten it loosely.
- ② Connect pipe No.1, pipe No. 2, Phase coil, pipe No. 3, pipe No.4 in the vertical element section and fastening them with tapping screws and external tooth washers by aligning holes in each joint section. Connect pipe No. 3 and pipe No. 4 with hose clamp. Adjust the insertion length of pipe No. 3 depending on the frequency. (Refer to the below chart)

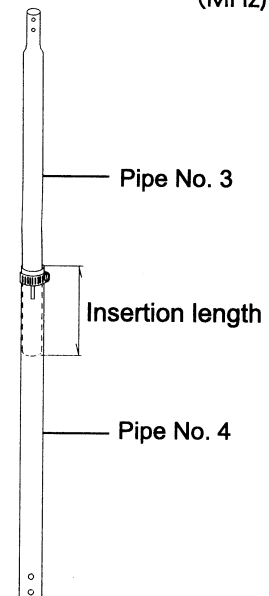
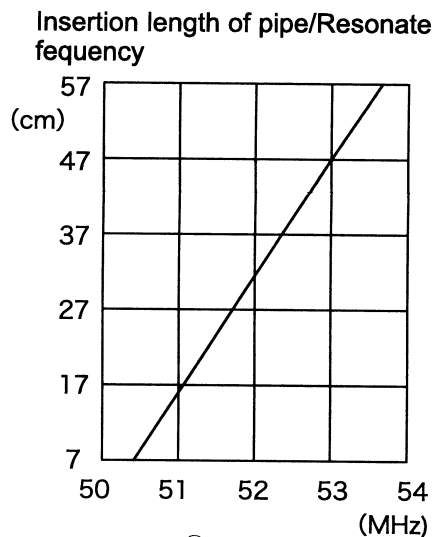

③ Attach mast support pipe to mast with mast brackets. Mast support pipe's tapping hole has to be placed above the brackets and it has to be pointed outside against the mast. Upper end of mast support pipe has to be placed more than 12cm(4.7") above the top end of the mast.

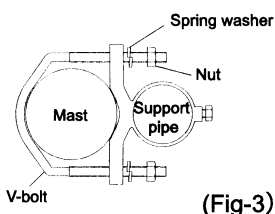
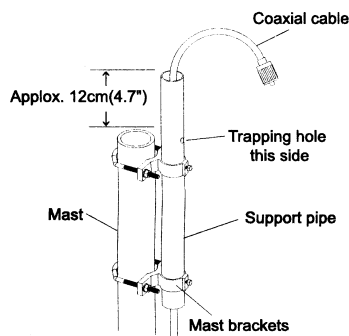

(Fig-3)

④ Place two radial element holders from upper end of the support pipe and fasten temporarily with screwdriver. Do not fasten too tightly at this stage, otherwise feedpoint assemblies might not be put into the support mast later.

⑤ Connect a coaxial cable to feedpoint assembly through the support pipe. Then align the hole in the lower part of feedpoint assembly with the hole in the support pipe and secure them with hex head screw and spring washer. (note) Please do the waterproof processing to the connector section.

⑥ Place vertical element on feedpoint assembly and fix with two hex head screws and spring washers.

⑦ Turn each radial element into radial element holders. Then align water drain hole in each radial element trap coil assembly downward by turning backward and fasten each element with grip nut, Note that 6m radial element does not have trap coil assembly.

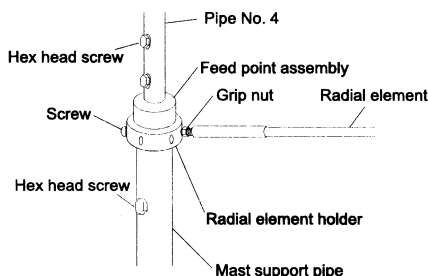

(Fig-4)

•Adjustment

<<Note for frequency adjustment>>
Practice the following adjustment procedure at the place where the antenna is actually installed.

Test transmission for the adjustment has to be performed for as short time as possible and with as low RF power as possible. Maximum RF power rating of continuous wave (CW) is about 1/3 of it in SSB mode.

① Prepare suitable VSWR meter for operation frequency and output RF power. Then connect it as shown in below.

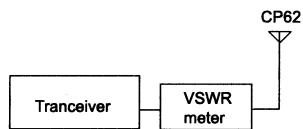

(Fig-5)

② When assembling, the insertion length of pipe No. 3 is adjusted but confirm it again. Adjust the insertion length of pipe No. 3 if the frequency is not adjusted.

•V.SWR

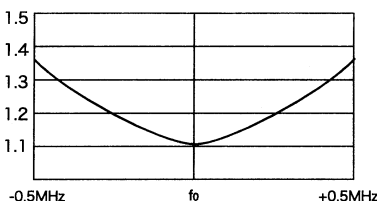

•Specifications

Frequency range	50-54MHz
Gain	5.5dBi
Maximum power rating	500W(SSB), 200(FM)
VSWR	Less than 1.5
Impedance	50Ω
Length	6.8m (max)
Weight	Approx. 2.7kg
Maximum wind resistance	79MPH (35m/sec)
Mast diameter accepted	1 1/5" - 2 1/3"(30-62φ)
Radial element length	1.5m
Type	2x5/8wave
Connector	M-J

Though these products purchased are manufactured under strict quality control, if damage is caused by transporting, ask your dealer promptly.

Design and specifications of these products will be changed for future improvement without advance notice.