



Pacific Accessory Corporation

SWI-PS

Universal Steering Wheel Control Interface

For Pioneer and Sony Radios
with wired remote inputs.

Installation Instructions

Before You Start



A. Is this product compatible with the vehicle?

- See application guide (seperate sheet) for listing of vehicles and connection information. If not, check www.pac-audio.com for an updated list of compatible vehicles.



B. Prepare for the installation.

- If possible, install the SWI-PS while you are installing the new head unit. Keep in mind you may need to plug in the factory stereo to locate certain wires; therefore do not complete the head unit installation until the SWI-PS is working properly.
- Plan a general installation location for both the SWI-PS plug and the control body. Keep in mind that the supplied wire harness is **two feet long**, and the 1/8" plug harness is **three feet long**.
- Use a multimeter or approved measuring device for checking vehicle circuits.

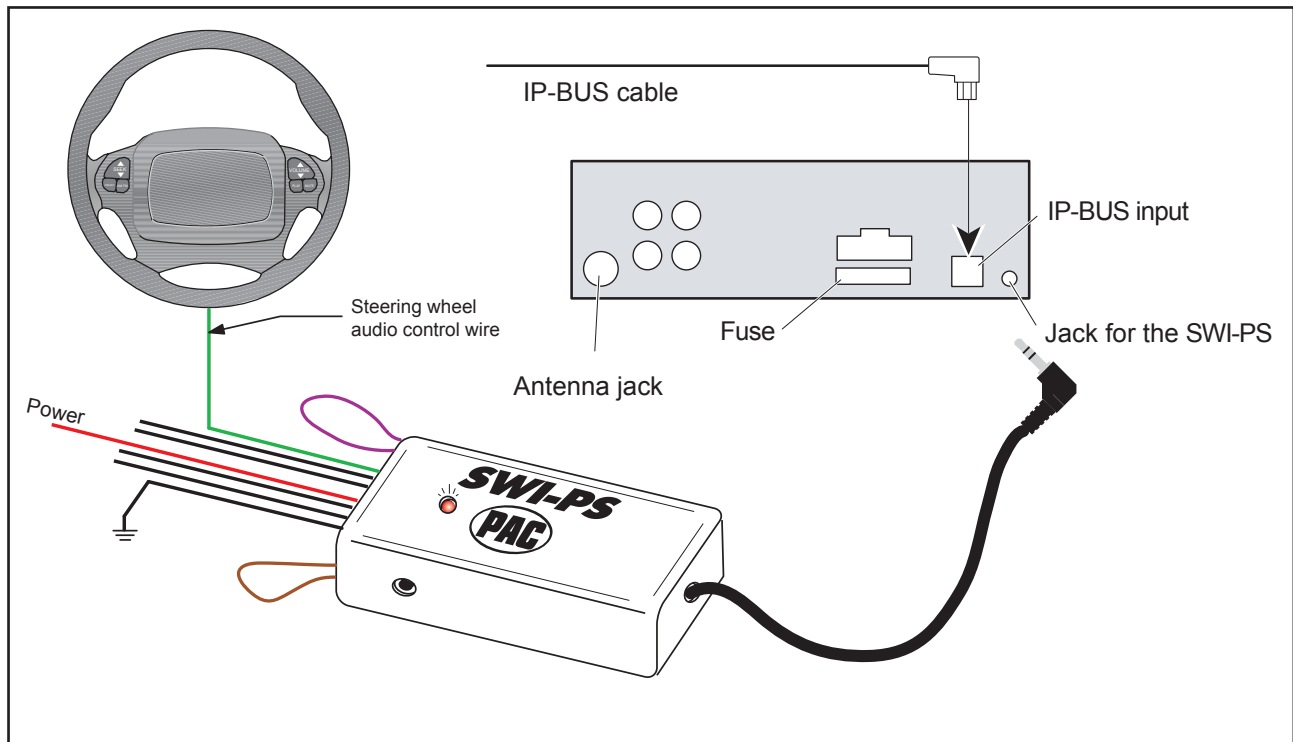

Wiring Connections

Note: Only 3 wires will be used during installation. Only GM vehicles programmed for version #4, will use 4 wires.

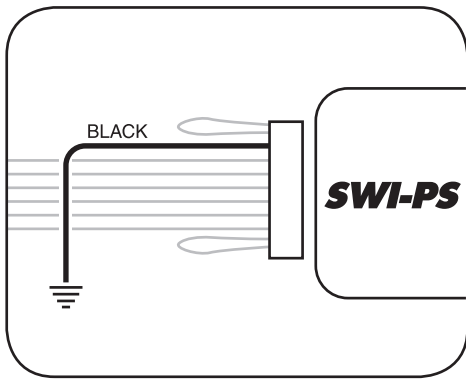

Step 1.
Connect the BLACK wire to ground (-).

Verification: Wire or location registers a constant (-) when probed.

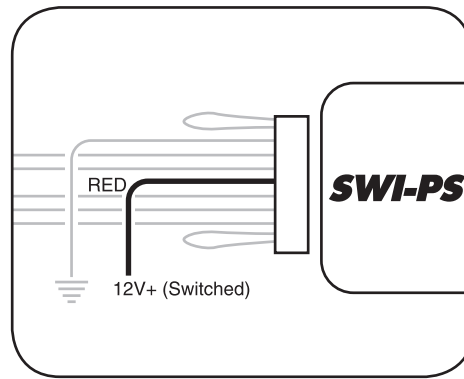

Step 2.
Connect the RED wire to switched +12V.

Verification: Wire registers +12V when the ignition key is turned to the ACC or ON positions.

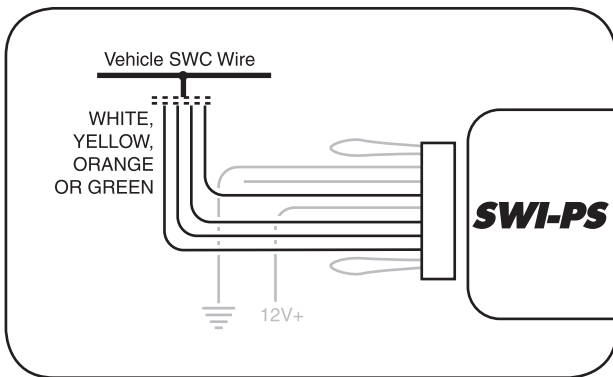

Step 3.
Connect the appropriate interface wire (WHITE, YELLOW, ORANGE or GREEN).
 • Refer to the **Identification and Connection Chart**. Locate the vehicle and note the SWC wire color in the "Interface Wire Color" column.
 • Note the vehicle wire color and location information in the "Identification" column.
Note: You will only connect ONE of these wires. The other 3 wires will not be used. Cut and insulate the unused wires.
 • Connect the wire as indicated in the chart.

Step 4

If necessary, perform the following operations as indicated by the notes in **Identification and Connection Chart**.

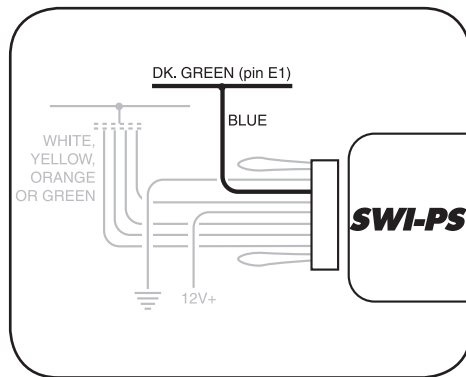

Step 4a.
Connect the BLUE serial data wire. Connect this wire **ONLY** on GM passenger vehicles (no trucks or SUVs) with airbags AND steering wheel heater controls. For all other vehicles, cut and insulate the BLUE wire.

Note: **Step 4a** is for vehicles made by General Motors that are programmed for version #4 only. If no connections is necessary, proceed to Step 4b.

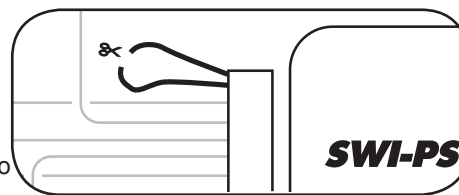

Step 4b.
If instructed by the **Vehicle Application Guide**, cut the BROWN wire loop and insulate both halves.

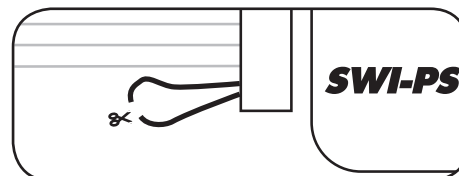

Step 4c.
If instructed by the **Vehicle Application Guide**, cut the VIOLET wire loop and insulate both halves, or place a resistor in-line of wires.

Programming the SWI-PS to Work With the Vehicle

Step 5.

Refer to **The Vehicle Application Guide**. Note the **INTERFACE Version Number** next to the selected vehicle. Fill in the information below for quick reference.

Version Number: _____
 (Write Version Number here)

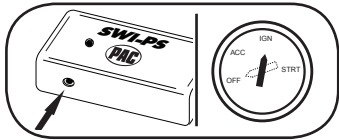

Step 6.
 Press and hold programming/
 mode button on SWI-PS. Turn the
 vehicle ignition to the ON position.

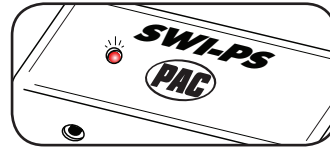

The LED on the
 SWI-PS will light.

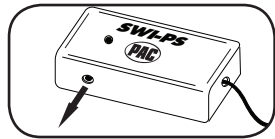

Step 7.
 Release the programming/
 mode button.

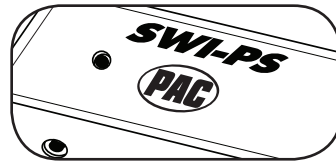

The LED will turn off,
 indicating memory is
 cleared.

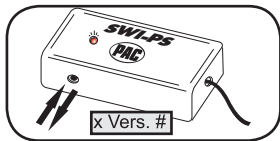

Step 8.
 Press and release the program-
 ming/mode button the same
 number of times as the desired
 version number.

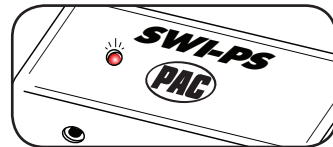

The LED will flash
 each time the button is
 pressed and released.

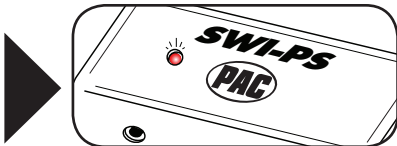

Step 9.
 After 3 seconds, the
 LED will flash the same
 amount of times of set
 version number.

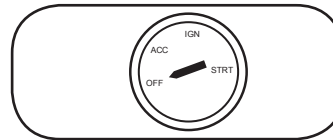

Step 10.
 Turn vehicle ignition
 to OFF position.
 Vehicle programming
 sequence is complete.

Programming the SWI-PS to Control the Head Unit

IMPORTANT! Some steps of the programming instructions **must be completed within a certain number of seconds following the previous step.** Review the complete instruction before beginning the programming sequence.

Step 11.

Turn the vehicle ignition to the ON position.

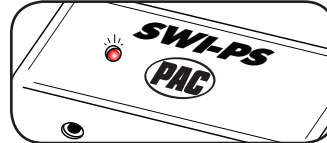
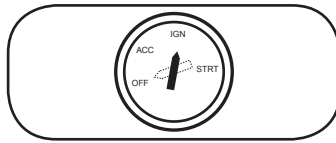

LED will flash to indicate set version number.

If you programmed the interface for version #4, proceed with the following steps.
If you did not program the interface for version #4, skip to Step 18.

Step 12.

Press and hold programming/mode button on SWI-PS.

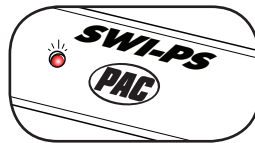
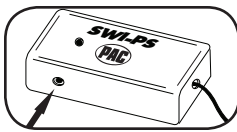

LED will light.

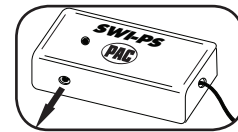

Step 13.

Release programming/mode button.

Step 14.

Press and hold the TEMP UP button on the steering wheel control.

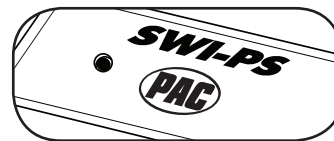
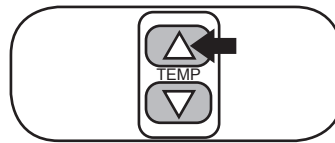

LED will turn off.

Step 15.

Release the TEMP UP button.

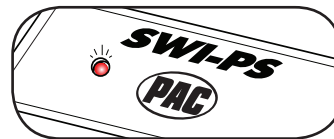
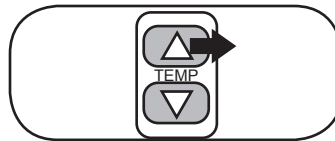

LED will turn on. The function is programmed.

Step 16.

Repeat Steps 14 and 15, using the TEMP DOWN Button.

Step 17a.

If the vehicle is equipped with FAN UP and FAN DOWN buttons:

Repeat Steps 14 and 15 for these buttons as well.



Step 17b.

If the vehicle is NOT equipped with FAN UP and FAN DOWN buttons:

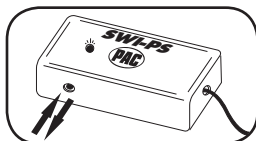

Press and release the programming/mode button on the SWI-PS.

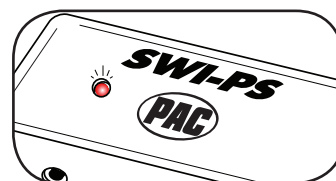

In either case, the LED will flash once and stay on. Skip to Step 20. You have 7 seconds to perform the next step.

Step 18.

Press and hold programming/mode button on SWI-PS.

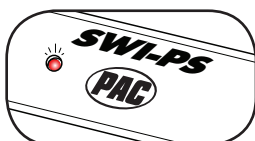
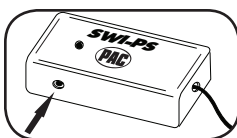

LED will light.

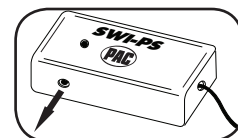

Step 19.

Release programming/mode button.

You only need to press the programming/mode button once to program all the buttons. If you press this button again after the interface is programmed, it will erase all previous learned buttons.

Programming the SWI-PS to Control the Head Unit (cont.)

The SWI-PS must be programmed in the specific order shown below. If a function is not needed, it may be skipped.

- | | | |
|---------------------|--------------------------|---------|
| 1. Volume Up | 5. Track Down/Seek Down | 9. Band |
| 2. Volume Down | 6. Source | |
| 3. Mute | 7. Preset Up/Disc Up | |
| 4. Track Up/Seek Up | 8. Preset Down/Disc Down | |

Example: If you have a vehicle with only 3 functions, and you want to program Volume Up, Volume Down and Source. You will do Step 21-22 twice, the first time for Volume Up, the second time for Volume Down. Step 23 will be done 3 times to skip Mute, Track Up and Track Down. Do Step 21-22 to program Source. After all 3 buttons have been programmed, you will proceed to Step 24.

Step 20.

- If the current function above is what you need to program, proceed to step 21.
- If the current function above is not needed, proceed to step 23

Step 21.

Within 7 seconds, press and hold the button that is to be learned on the steering wheel.

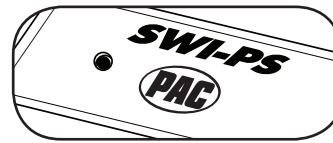
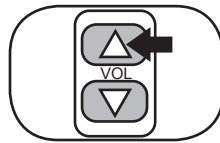

The LED will turn off when the button has been learned.

Step 22.

Release the button.

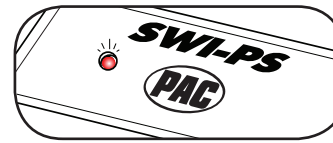
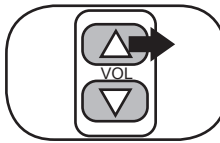

The LED will turn on back on. **Skip to Step 24.**

Step 23.

Within 7 seconds, press and release the programming/mode button on the SWI-PS.

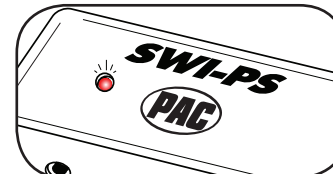
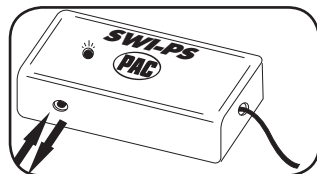

The LED will flash once and stay on. This will indicate that the function has been skipped. **Skip to Step 20.**

Step 24.

If you need to program more buttons, repeat step 20 for each additional audio function on the steering wheel.

Program remaining buttons



After all buttons are programmed

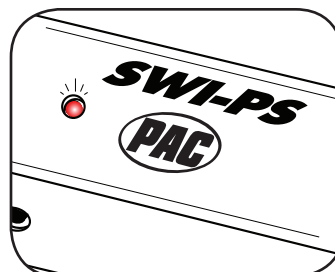

Once programming is completed, wait 7 seconds. The LED will flash three times indicating end of programming. The Interface will then flash the version number it was programmed for.

Testing the SWI-PS

Note: For Sony head units, please refer to the note below.

Test each Heater function of the steering wheel controls. The TEMP and FAN should work properly. When testing the audio controls, the left LED on the SWI-PS will flash indicating it is sending a command. If any function does not work, repeat the programming instructions (starting from Step 11) or refer to **Troubleshooting Guide**.

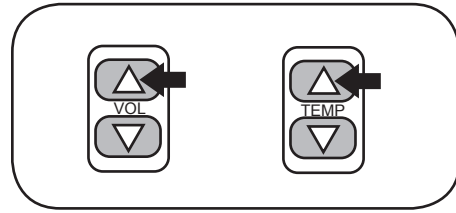

Sony Head Units only!: If the Volume and Track/Seek settings are reversed, you need to program the head unit to reverse the input. Please refer to the radio's Owners Manual to change this feature for the wired remote.

Appendix A: Known Incompatible Vehicles

Vehicle Make(s)	Year(s)	Model(s)
BMW	All	All with factory-activated cellular phones All with 5-volt SWC data wire at the steering column
	2002-2003	5-Series w/navigation
Mercedes-Benz	All	All vehicles
Toyota	All-2003	Sienna
Volkswagen	2002-up	All vehicles

Appendix B: Resistor Kit

Some vehicles have a separate wire for each of the steering wheel buttons. Use this resistor kit for the steering wheel push buttons that do not already have a resistor network connected to them. Examples are Nissan and Harley Davidson motorcycles.

Connect a resistor to each side of a push button and connect the other ends of the resistor all together. Connect the SWI-PS to these resistors. On the Harley Davidson, one button can be connected directly to the SWI-PS.

- 47 = yel, vio, blk
- 100 = brn, blk, brn
- 150 = brn, grn, brn
- 560 = grn, blu, brn
- 1000 = brn, blk, red
- 1500 = brn, grn, red
- 3900 = org, wht, red
- 5100 = grn, brn, red

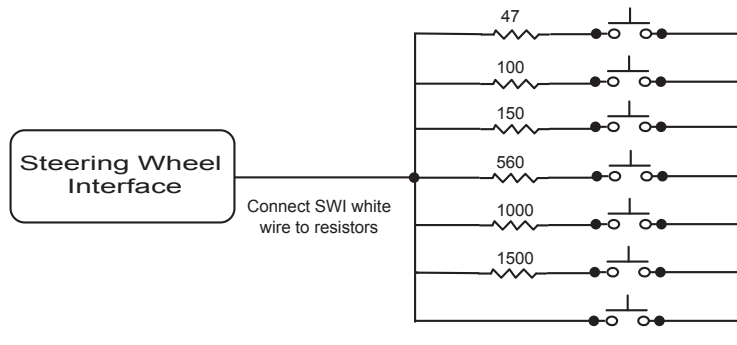

By putting two or more resistor in series, you can come up with additional values. Ex. $150 + 1000 + 1500 = 2650\text{ohms}$.

Troubleshooting Guide

No power / won't go into programming mode:

- Check **Red** wire connection and fuse. Make sure INTERFACE is connected to switched +12volts, not constant +12volts.
- Make sure vehicle ignition is on.

The INTERFACE controls the stereo immediately without pressing any buttons on the steering wheel:

- During programming, press the buttons on the steering wheel firmly until the left LED turns off. Releasing the button too early will cause the INTERFACE to send out a signal even when no buttons are pressed.

The INTERFACE controls the radio whenever the steering wheel is turned (mostly late 80's early 90's Honda/Acura).

- Program the INTERFACE for version #11.

When ever I program a new button the previous button does not work.

- You must program all buttons during programming. If you try to program another button, all previous button will be erased. You will have to relearn all previous buttons again.

Working on a new or unlisted vehicle?

We are always looking for new vehicle information. If you've successfully completed the installation on a vehicle with steering wheel controls, and the vehicle is not listed in these instructions or on our Website, contact us at techsupport@pac-audio.com so that we may add the information to the instructions.

Pacific Accessory Corporation

1502 S. Santa Fe St. • Santa Ana, CA 92705

techsupport@pac-audio.com • www.pac-audio.com

Copyright 2005 Pacific Accessory Corporation. Content subject to change without notice.